

(L = 23)

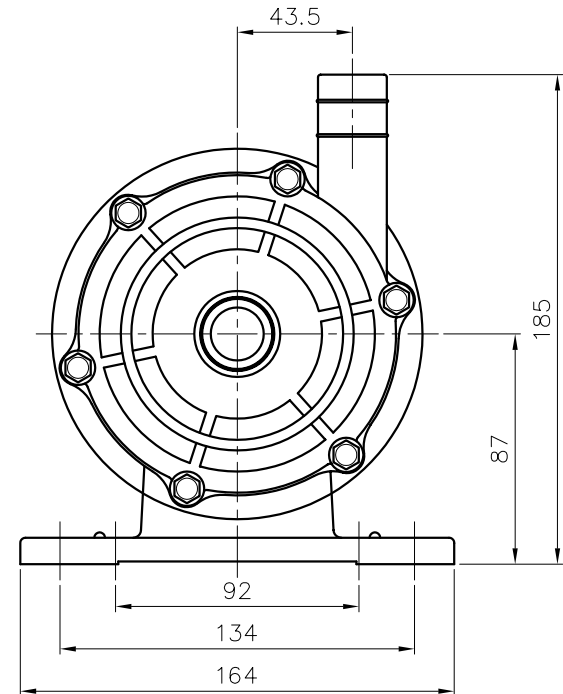
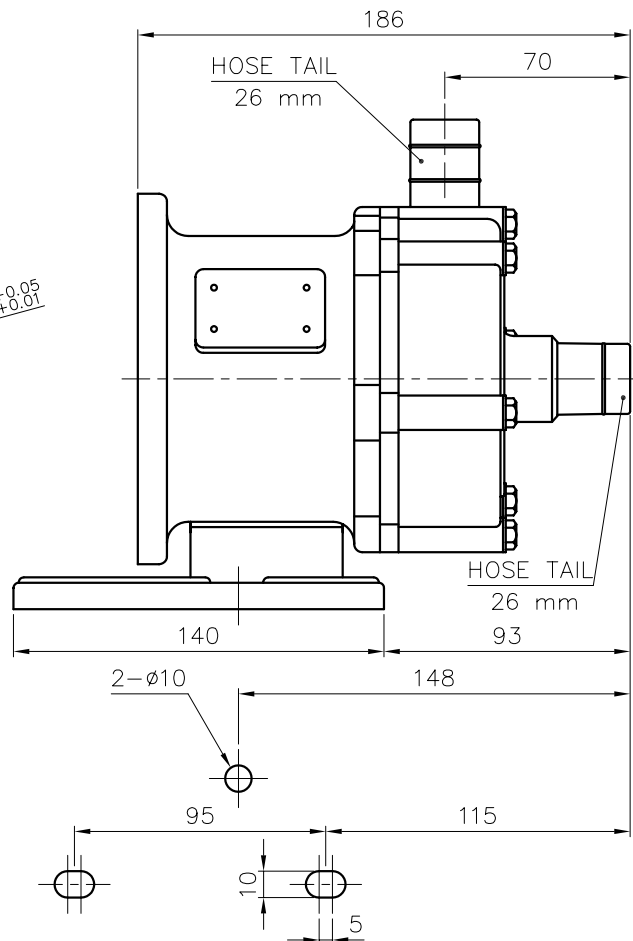

Frame No. : 63M

DIMENSION TOLERANCE : JIS 16 CLASS

APPROVED		MDL, NAME	NH-250PS-3E NH-250PS-3E-F
UNIT	MM	CHECK	08 09 11
SCALE	1:2	DESIGN	12 14 94
EDITION	3	DR.BY	08 09 11 FANNY
		DWG, NAME	INSTALLATION DRAWING
		DWG, NO.	E1252098 A3

TPW
HONG YUAN



PAN WORLD CO.,LTD.
パンワールド株式会社