

	Suction 50A			Discharge 32A		
	A	B	C	AA	BB	CC
JIS 16K	120	8- ϕ 19	100	100	4- ϕ 19	80
DIN PN 16	125	4- ϕ 18	102	100	4- ϕ 18	78

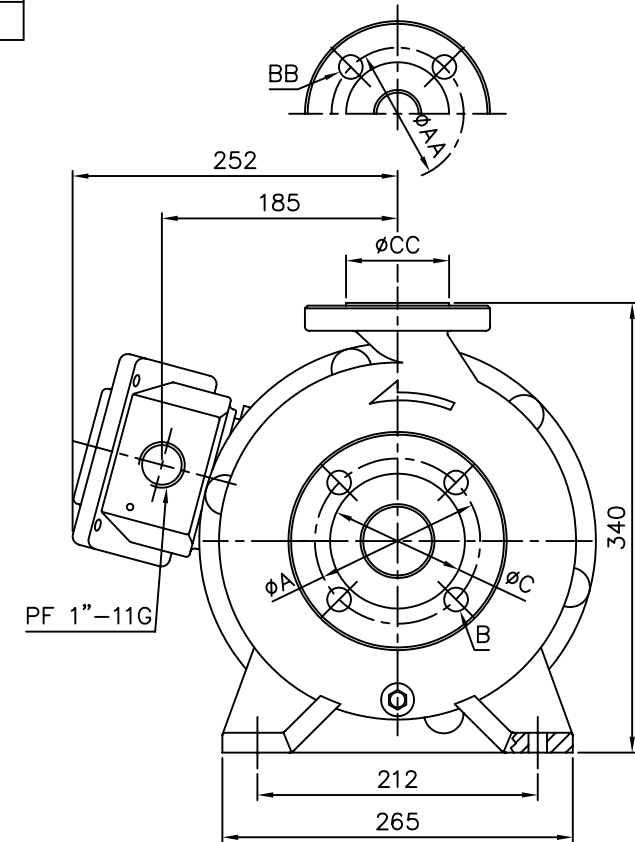
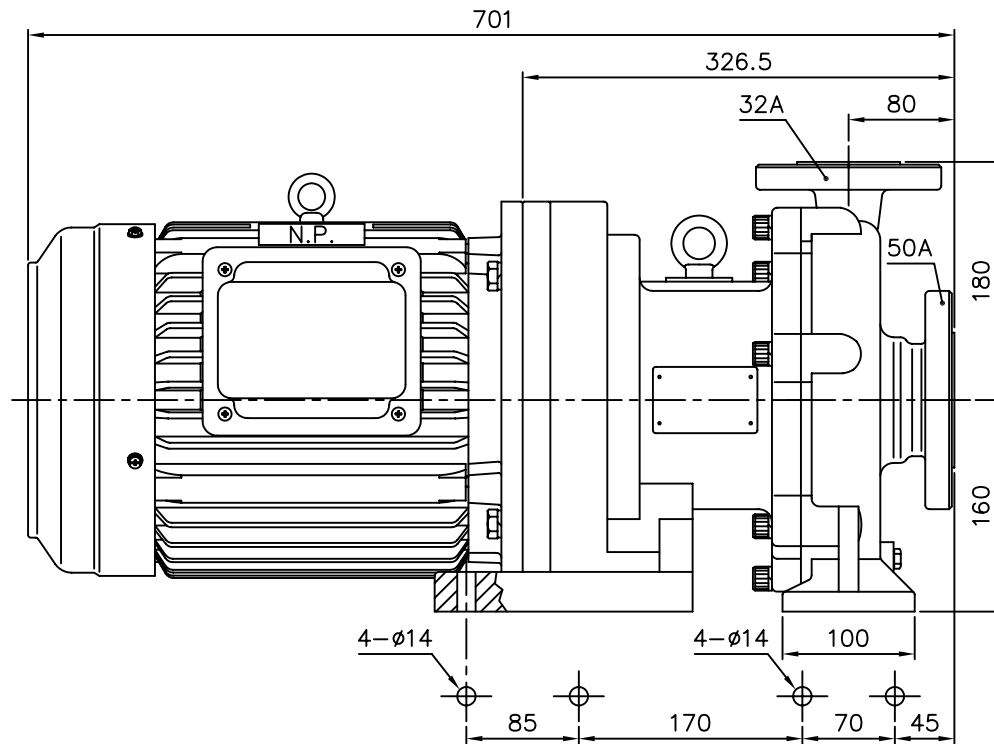

DIMENSION TOLERANCE : JIS 16 CLASS

		APPROVED		MDL, NAME	
UNIT	MM	CHECK	12 06 02	DWG, NAME	INSTALLATION DRAWING
SCALE	1:4	DESIGN	11 16 00	DWG, NO.	B1326794 A3
EDITION	1	DR.BY	12 06 02 BECKY		
TPW HONG YUAN		PAN WORLD CO.,LTD. パンワールド株式会社			

NH-32-100PG NH-32-200PG
 NH-32-120PG NH-32-210PG
 NH-32-140PG
 NH-32-160PG (7.5kW)
 NH-32-180PG