

(L=30)

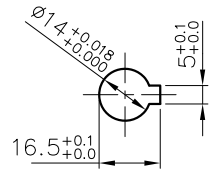

SCALE = 1:2

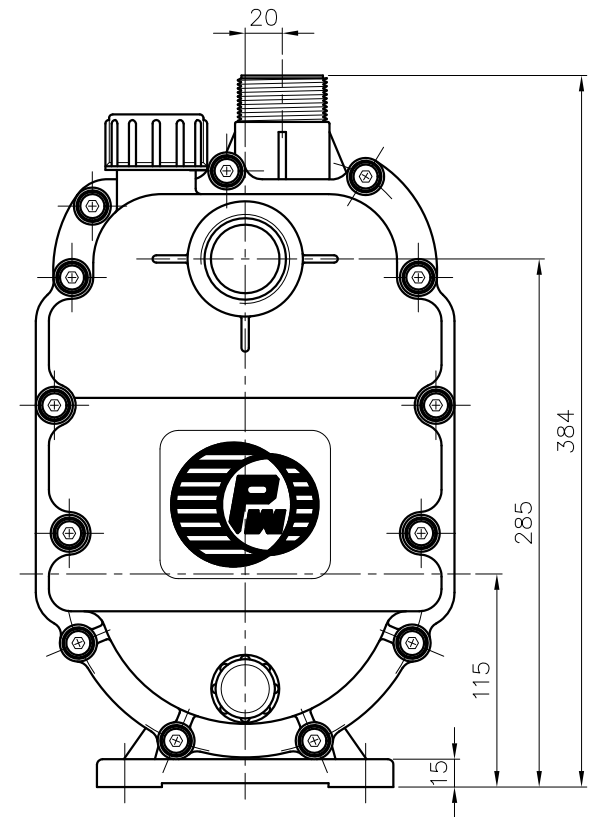
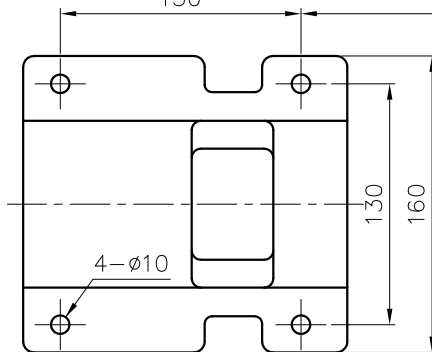

DIMENSION TOLERANCE : JIS 16 CLASS

APPROVED		MDL. NAME		NH-400PW-N NH-400PW-N-K	
UNIT	MM	CHECK	06 25 12	DWG. NAME	INSTALLATION DRAWING
SCALE	7:20	DESIGN	03 17 06	DWG. NO.	E1403607
EDITION	2	DR. BY	06 25 12 FANNY		A3

TPW
HONG YUAN



PAN WORLD CO.,LTD.
パンワールド株式会社